

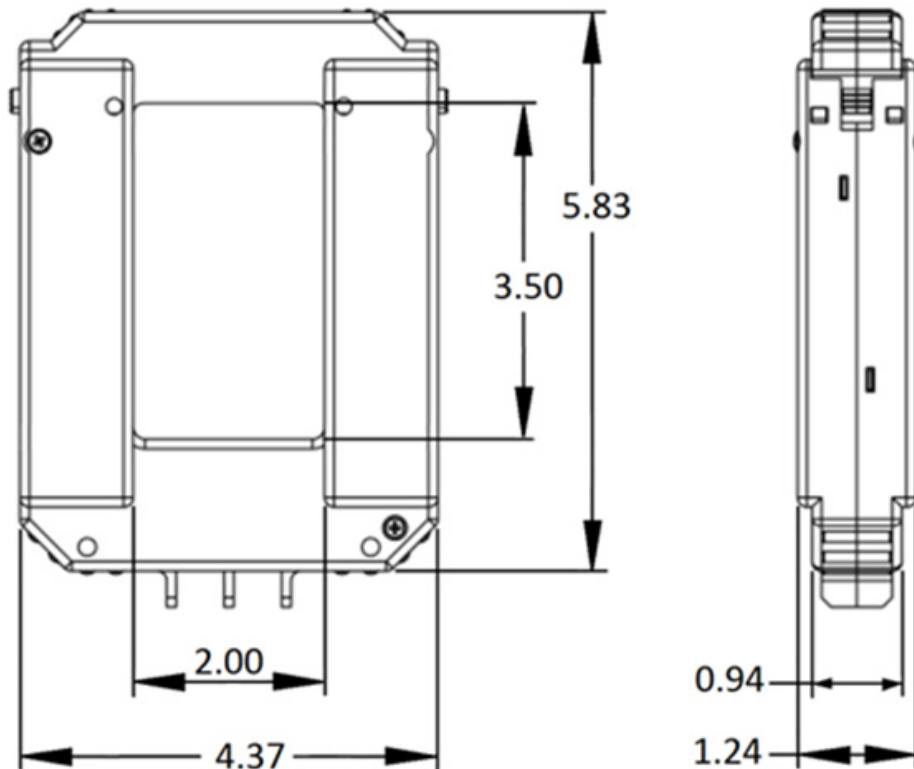

CT600/5A CURRENT TRANSFORMER

Model		CT600/5A
Model Description		Curent Transformer- Primary Side 600A
Weight		1.1 lbs (.5 kg)
Operating Temperature		5° F to 149°F (-15° C to 65° C)
Operating Humidity Range		25-90% Relative Humidity
Electrical Specifications	Current Ratio	600:5
	Burden (VA)	2.75
	Accuracy @ 60hz	.5
Standards		IEEE C57.13 & IEC 60044-1, UL 61010-1 & CAN/CSA C22.2, IEC 61010-2 & ANSI C12.20
Standard Warranty		2 Years/Unlimited Hours
Maintenance & Extended Warranty Plans <i>(Optional YES Product Protection Available as part of a complete mCHP system.)</i>		10 Years/30,000 Hours; <i>Whichever Comes First</i>
		10 Years/60,000 Hours; <i>Whichever Comes First</i>
		15 Years/90,000 Hours; <i>Whichever Comes First</i>

Dimensional Drawings:
Units: Inches



NOTE: Due to YANMAR's ongoing commitment to quality, specifications, ratings and dimensions subject to change without notice. Improper installation, adjustment, alteration, service or maintenance can cause property damage or personal injury. Installation and service must be in accordance with current specifications, ratings and dimensions and be performed by a qualified installer and servicing agency.