



Submittal Data Sheet
0.5-Ton MSP Concealed Ducted Unit
FXSQ05TAVJU

PERFORMANCE

Indoor Unit Model No.	FXSQ05TAVJU	Indoor Unit Name:	0.5-Ton MSP Concealed Ducted Unit
Type:	Ducted	Rated Cooling Conditions:	Indoor (°F DB/WB): 80 / 67 Ambient (°F DB/WB): 95 / 75
Rated Cooling Capacity (Btu/hr):	5,800	Rated Heating Conditions:	Indoor (°F DB/WB): 70 / 60 Ambient (°F DB/WB): 47 / 43
Sensible Capacity (Btu/hr):	4,700	Rated Piping Length(ft):	
Cooling Input Power (kW):	0.104	Rated Height Separation (ft):	
Rated Heating Capacity (Btu/hr):	6,500		
Heating Input Power (kW):	0.10		

INDOOR UNIT DETAILS

Power Supply (V/Hz/Ph):	208/230 / 60 / 1	Airflow Rate (H/M/L) (CFM):	281/265/230
Power Supply Connections:	L1, L2, G	Moisture Removal (Gal/hr):	
Min. Circuit Amps MCA (A):	0.8	Gas Pipe Connection (inch):	1/2
Max Overcurrent Protection (MOP) (A):	15	Liquid Pipe Connection (inch):	1/4
Dimensions (HxWxD) (in):	9-11/16 x 21-11/16 x 31-1/2	Condensate Connection (inch):	1
Net Weight (lb):	55	Sound Pressure (H/M/L) (dBA):	33/30/28
Ext. Static Pressure (Rated/Max) (inWg):	0.2 / 0.6	Sound Power Level (dBA):	61

Submittal Data Sheet
 0.5-Ton MSP Concealed Ducted Unit
 FXSQ05TAVJU

DIMENSIONAL DRAWING

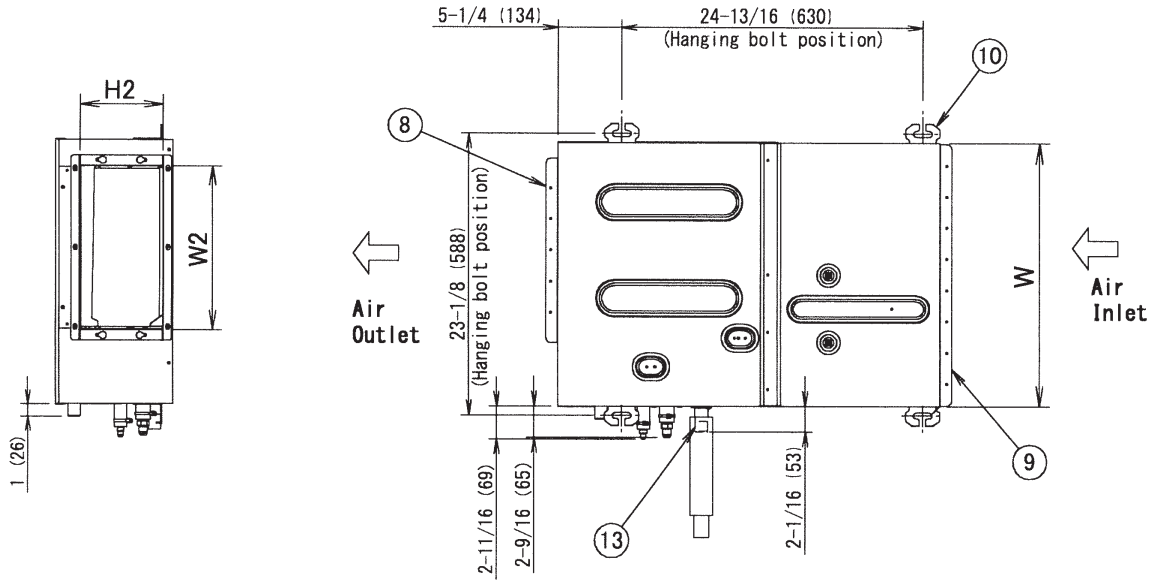

(From the Air Outlet)

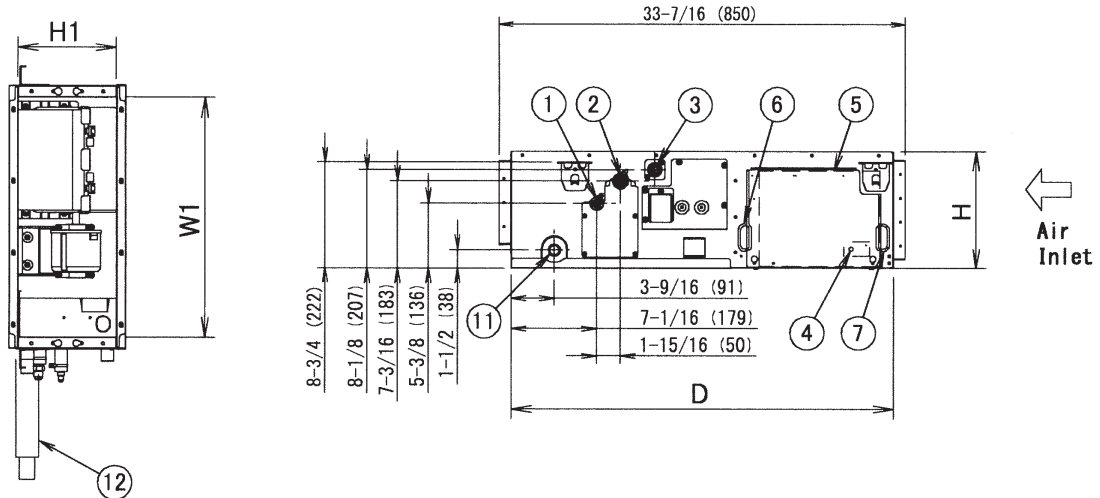

1 3	Drain socket	
1 2	Drain hose (Accessory)	
1 1	Socket (for maintenance)	O. D. ϕ 1" (ϕ 26)
1 0	Hanger	For M10 or equivalent
9	Air Inlet flange	
8	Air Outlet flange	
7	Power supply wiring connection	
6	Transmission and remote controller wiring connection	
5	Control box (inside)	
4	Ground terminal (Control box)	M4
3	Drain pipe connection	O. D. ϕ 1-1/4" (ϕ 32)
2	Gas pipe connection	ϕ 1/2" (ϕ 12.7) Flare connection
1	Liquid pipe connection	ϕ 1/4" (ϕ 6.4) Flare connection
ITEM	PART NAME	REMARK

H		9-11/16 (245)
W		21-11/16 (550)
D		31-1/2 (800)
Air Inlet	H1	8-3/16 (208)
	W1	19-3/4 (502)
Air Outlet	H2	6-15/16 (176)
	W2	13-1/4 (337)

Note: For additional dimensional data and clearance information, refer to Engineering Data